

HenryGlass[®]

APERTURE CONTEMPORANEE

NEWS 2022

Indice

_Index

SISTEMI DI APERTURA / WALL SYSTEM

04

LINEA MANHATTAN

PORTA A BILICO / PIVOT DOOR

PORTA A BATTENTE 180 / 180 SWING DOOR

GRID / NEW COLLECTION

LINEA ADELA

PORTA A BILICO / PIVOT DOOR

LINEA VITRA/MANHATTAN

STIPITE CUBE / CUBE FRAME

SISTEMA PARETI / WALL SYSTEM

DECORI / DECORATIONS

64

WALLPAPER

HERITAGE

TWEED

ORIGIN

OPEN UP

OLTRE LA MATERIA / NEW COLLECTION

GALUCHAT

SHODO

THAI

RAMIÈ

GREY PLASTER

Parliamo di un progetto che nasce dal culto per la materia, dall'amore per il bello e dalla predilezione per le scelte fatte con stile... uno stile riconoscibile e accurato nei dettagli, mai scontato. Quest'armonia di elementi viene scoperta da HenryGlass per dar vita a una collezione di porte contemporanee, nate per trasmettere valori ed emozioni che in alcuna maniera possono confondersi con altro.

We are talking about a design that stems from a worship of matter, from a love for beauty and from a preference for decisions made with style... a recognisable style, attentive to the details, never predictable. This harmony of elements is unveiled by HenryGlass to offer a collection of contemporary doors, created to convey values and emotions which, in no way whatsoever, can be confused with one another.



SISTEMI DI APERTURA

_OPENING SYSTEMS

Un approccio progettuale prima ancora che estetico, attraverso proposte create per emozionare e generare atmosfere uniche. La porta a bilico, scenografica ed imponente nelle sue proporzioni, la collezione Manhattan arricchita da nuovi dettagli, lo stipite Cube ideato per inserirsi armoniosamente nel contesto delle pareti divisorie, rappresentano ulteriori tasselli per un dialogo sempre più completo con il mondo dell'architettura contemporanea.

A design approach before an aesthetic approach, through proposals created to excite and generate unique settings. The pivot door, scenographic and impressive in its proportions, the Manhattan collection enriched with new details and the Cube frame designed to fit harmoniously into the context of the partition walls represent further pieces for an increasingly more comprehensive dialogue with the world of contemporary architecture.

Un catalogo ispirato ad un'architettura essenziale e ricercata per interpretare, attraverso il vetro e la materia, il delicato dialogo tra la natura degli spazi e i sistemi di apertura.

A catalogue inspired by essential, refined architecture to interpret - through the glass and the material - the delicate dialogue between the nature of the spaces and the opening systems.



_ LINEA MANHATTAN

_ PORTA A BILICO / PIVOT DOOR

_ PORTA A BATTENTE 180 / 180 SWING DOOR

_ GRID / NEW COLLECTION

L'eleganza senza tempo della porta intelaiata Manhattan - firmata da Nicola Gallizia - con il modello a bilico si arricchisce di nuove funzionalità ma anche di miglioramenti tecnici e nuove suggestioni estetiche.

The timeless elegance of the Manhattan framed door - designed by Nicola Gallizia - with the pivot model is enriched with new features but also with technical improvements and new aesthetic proposals.

PORTA A BILICO

_PIVOT DOOR

Le porte a bilico HenryGlass riprendono gli stilemi estetici della battente Manhattan, ma è la modalità di apertura che le rende uniche caratterizzandone l'estrema versatilità. Una cerniera-pivot invisibile, inserita a scomparsa nel profilo perimetrale ed installabile sia al centro che a lato, consente la rotazione dell'anta sul proprio asse modificando magicamente il rapporto tra interno ed esterno.

Certificate per garantire una portata fino a 150 kg, le porte a bilico possono raggiungere dimensioni notevoli, dando vita ed aperture estremamente interessanti a livello progettuale per definire una percezione di spazio fluida, inaspettata e flessibile.

Non necessitano di cornici né stipiti, ma volendo possono essere abbinati allo stipite Cube che ne vincola l'apertura.

HenryGlass pivot doors reflect the aesthetic and stylistic features of the Manhattan swing door, but the opening system makes them unique, characterising their extreme versatility. An invisible pivot hinge, hidden within the perimeter profile and which can be placed either at the centre or to the side, allows the door to rotate on its axis, magically modifying the relationship between the inside and the outside.

Certified to guarantee a load up to 150 kg, the pivot doors are available in considerable sizes, thereby creating extremely interesting openings at the design level to define a fluid, unexpected and flexible perception of space.

The doors do not require frames or jambs, but, if desired, they can be combined with the Cube frame that limits their opening.



Dettaglio anta con cerniera laterale

_Door detail with lateral hinge



Dettaglio anta con cerniera centrale

_Door detail with central hinge



Manhattan _ Quattro porte a bilico in linea, vetro trasparente, maniglie Slim, finitura ottone

Manhattan _ Four in-line pivot doors, clear glass, Slim handles, brass finish



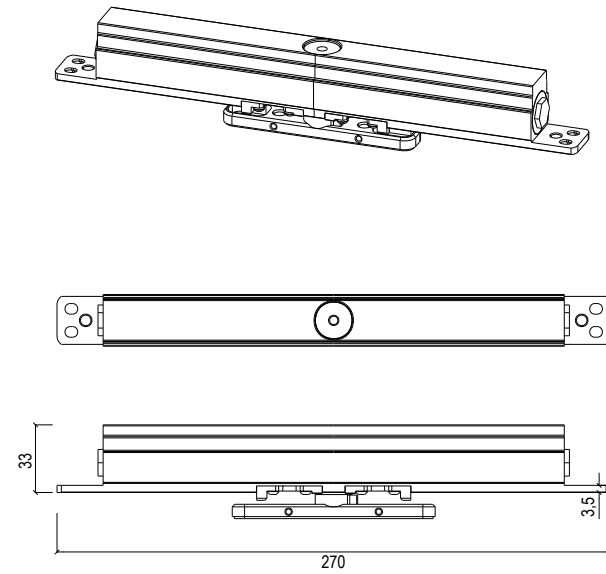

Dettagli tecnici cerniera porta a bilico
 _Technical details pivot door's hinge

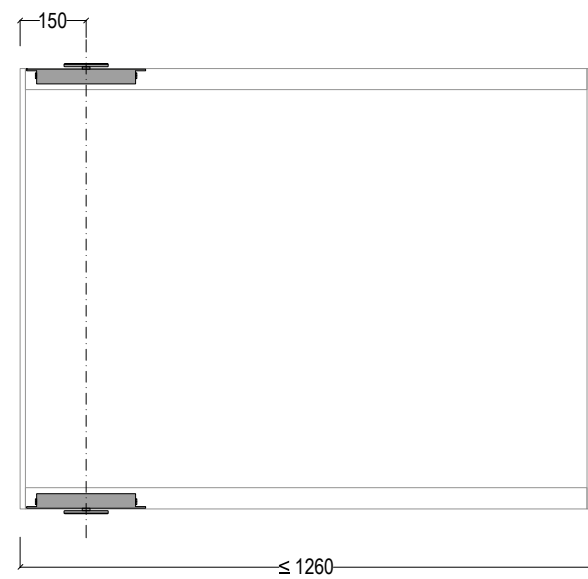

Cerniera porta a bilico e posizionamento sull'anta
 _Pivot door's hinge and positioning on the door

Per dimensioni maggiori di 1260x3000 mm richiedere preventivo in azienda
 _For dimensions bigger than 1260x3000 mm enquire the price to the company.

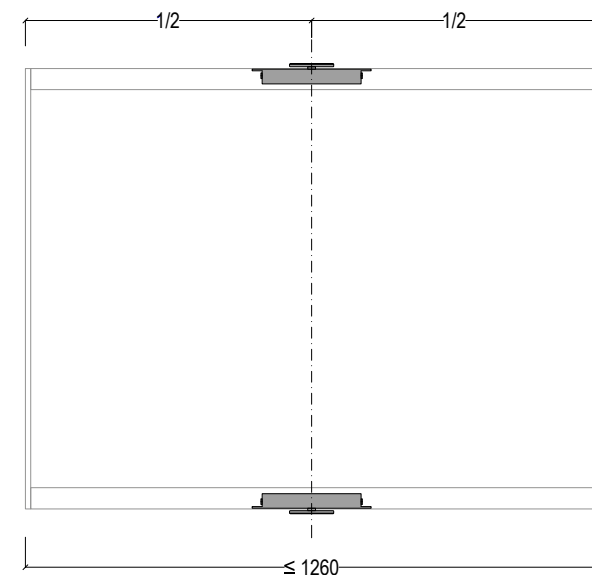

Sezione del profilo inferiore dell'anta
 _Section of the lower profile of the door

Porta a bilico Manhattan con battuta nel caso di abbinamento con stipite Cube
 _Manhattan pivot door with doorstop in case of combination with Cube frame

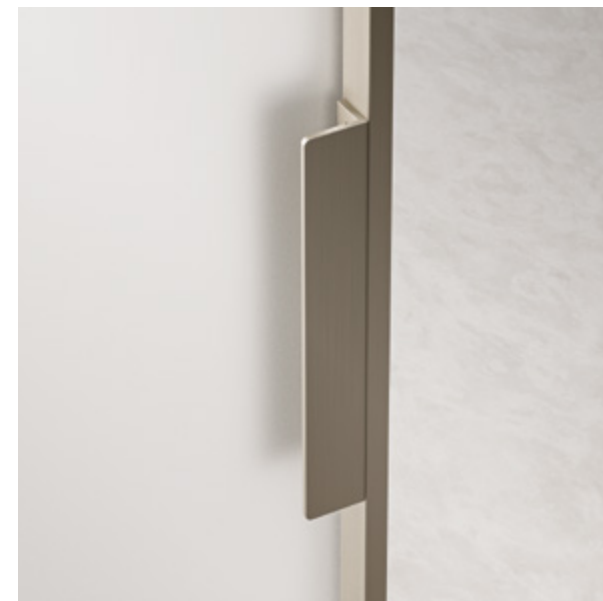

Maniglia Slim
 _Slim handle



Maniglia Square
 _Square handle

PORTA A BATTENTE 180

_180 SWING DOOR

La progettazione di una porta HenryGlass si concentra sui dettagli che nascono per rendere più funzionali i prodotti ed essere in armonia con lo stile di ambiente e arredo.

Questo nuovo modello di porta a battente Manhattan è stato implementato con il concetto della cerniera tubolare a tutta altezza che, da sempre, ha reso distintive le porte a battente della linea Vitra. Tale miglioria, oltre a caratterizzarne l'estetica, rende le porte facilmente installabili e regolabili.

The design of a HenryGlass door focuses on the details which are used to make products more functional and are designed to be in harmony with the style of the environment and furniture.

This new model of Manhattan swing door has been created with the concept of a full-height, tubular hinge which has always given the Vitra line of swing doors an added distinctiveness. This improvement, in addition to characterising the aesthetics, makes the doors particularly easy to install and adjust.



Dettaglio porta chiusa

_Closed door detail



Dettaglio porta aperta a 180°

_Door open at 180° detail





Manhattan _ Doppie porte a battente 180 su stipiti Plain, vetro trasparente, decoro Shodo 03, maniglie Life, finitura moka

Manhattan _ Double swing doors 180 on Plain frame, clear glass, Shodo 03 decoration, Life handles, moka finish





Possibilità di apertura a 180° dell'anta
_Ability of opening the door to 180°

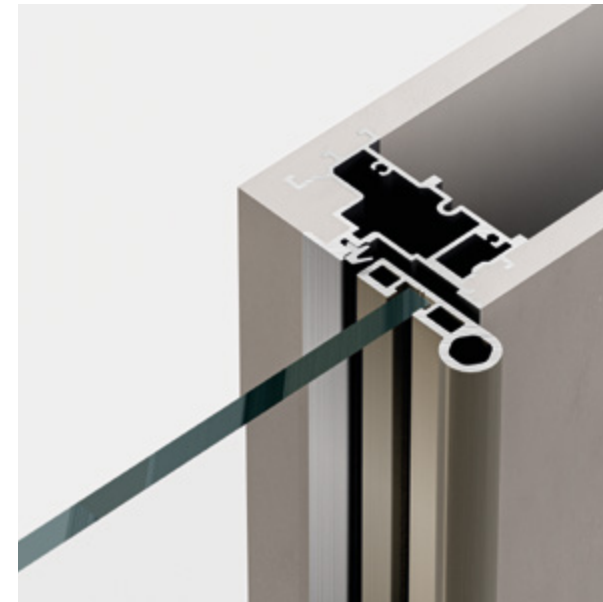

Porta a battente 180 su stipite Plain
_Hinged door 180 on Plain frame

Si tratta di un'anta intelaiata facilmente installabile e regolabile in fase di posa grazie al nuovo profilo-cerniera che permette l'inserimento, al suo interno, del sistema di regolazione già collaudato per la porta a battente Vitra. Il nuovo sistema di rotazione decentrato permette, in molti casi, l'apertura dell'anta fino a 180°.

_It is a framed door that can be easily installed and adjusted during installation thanks to the new hinge-profile that allows the insertion, inside the profile, of the adjustment system for the Vitra swing door. The new decentered rotation system allows, in many cases, the opening of the door up to 180°.



Porta a battente 180 su stipite Plain
_Hinged door 180 on Plain frame

GRID

_NEW COLLECTION

La scelta di porte in stile inglese è legata ad una questione di design ma anche al desiderio di ricreare ambienti dall'intramontabile fascino retrò. La collezione Grid richiama le suggestioni dello stile industriale dalle forme pulite, squadrate e minimal.

Nicola Gallizia ha firmato per HenryGlass quattro nuovi modelli raffinati ed estremamente contemporanei in grado di creare, da soli o in abbinamento ad altri disegni, configurazioni equilibrate e dal forte impatto estetico.

The choice of English-style doors is tied to a question of design but also to the desire to recreate environments with a timeless, retro charm. The Grid collection recalls elements of the industrial style with clear, squared, minimal forms. Nicola Gallizia has designed four new refined and extremely contemporary models for HenryGlass that are able to create, either alone or combined with other designs, balanced configurations with a strong aesthetic impact.



Dettaglio decoro Grid su anta a battente con carter / maniglia
_Grid decoration detail on hinged door with casing / handle



Dettaglio decoro Grid su anta scorrevole con maniglia Square
_Grid decoration detail on sliding door with Square handle



MANHATTAN

GRID

MANHATTAN

GRID

27



Manhattan _ Scorrevole esterno muro Inside, vetro satinato,
deco Grey Plaster, Grid 06 e Grid 01, finitura nero

Manhattan _ Inside external wall sliding door, frosted glass,
Grey Plaster decoration, Grid 06 and Grid 01, black finish





GRID 05

MODELLI DISPONIBILI _AVAILABLE MODELS



GRID 06



GRID 07



GRID 08

Nelle immagini sopra riportate la collezione Grid è visualizzata su ante scorrevoli Manhattan. Naturalmente, nel caso di porte a battente la maniglia Square deve essere sostituita con il carter maniglia.

In the images above, the Grid collection is displayed on Manhattan sliding doors. Of course, in the case of hinged doors, the Square handle must be replaced with the casing / handle.



_LINEA ADELA

_PORTA A BILICO / PIVOT DOOR

L'anta a bilico Adela nasce per regalare ad ogni spazio una nuova dimensione. Il pannello in legno ruota attorno al proprio asse verticale con un'apertura ampia, funzionale e in grado di emozionare proprio grazie alla particolarità del movimento.

The Adela pivot door was created to give each space a new dimension. The wood panel rotates around its vertical axis for a wide, functional opening that can truly engage the emotions thanks to the particular nature of the movement.

PORTA A BILICO

_PIVOT DOOR

In posizione chiusa si integra perfettamente nella parete circostante, mentre in posizione aperta risulta imponente.

È proprio in questo che risiede la forza del sistema a bilico: si tratta di porte pivotanti in grado di influenzare lo spazio ma anche la funzionalità e la percezione dello stesso.

Dall'estetica particolarmente piacevole, le porte a bilico nascondono una cerniera a pivot verticale che le rende capaci di ruotare attorno al proprio asse. Pratiche e funzionali, pur richiedendo un ingombro minimo, possono avere dimensioni anche notevoli. Le porte a bilico, inoltre, non necessitano di stipiti e possono dunque integrarsi perfettamente in ogni tipo di parete.

When closed, it integrates perfectly into the surrounding wall, whilst when open, it is undeniably impressive. This is precisely where the strength of the pivot system lies: these pivoting doors are able not only to influence the space but also the functionality and perception of the space itself.

With a particularly pleasing aesthetic quality, pivot doors hide a vertical pivot hinge that allows them to rotate on their axis. Practical and functional, even if a minimum size is required, they can also be created with quite significant dimensions. Furthermore, pivot doors do not require frames and can, therefore, be perfectly integrated into any type of wall.



Dettaglio anta con cerniera laterale
_Door detail with lateral hinge



Dettaglio anta con cerniera centrale
_Door detail with central hinge



Adela _Porte a bilico, rovere grafite, maniglie incassate

Adela _Pivot doors, graphite oak, recessed handles



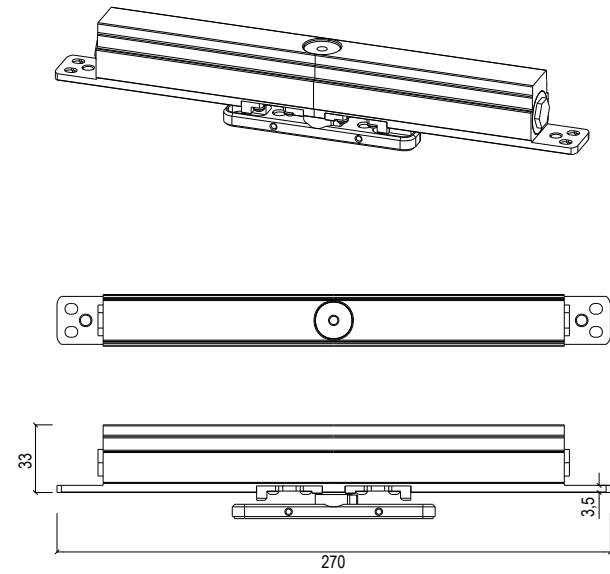

Dettagli tecnici cerniera porta a bilico

_Technical details pivot door's hinge

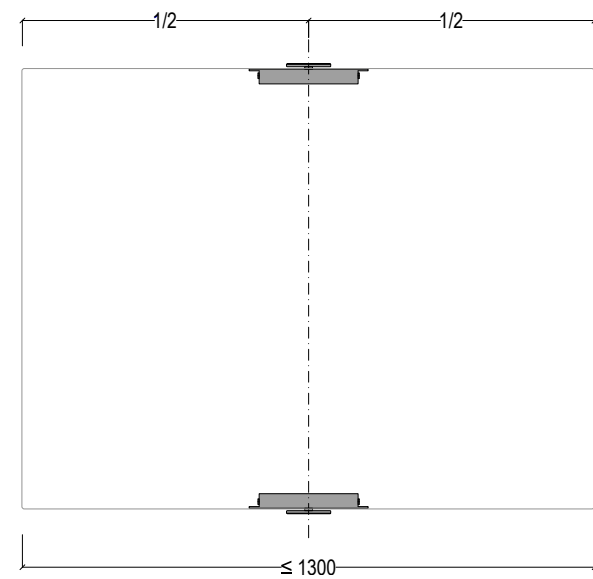
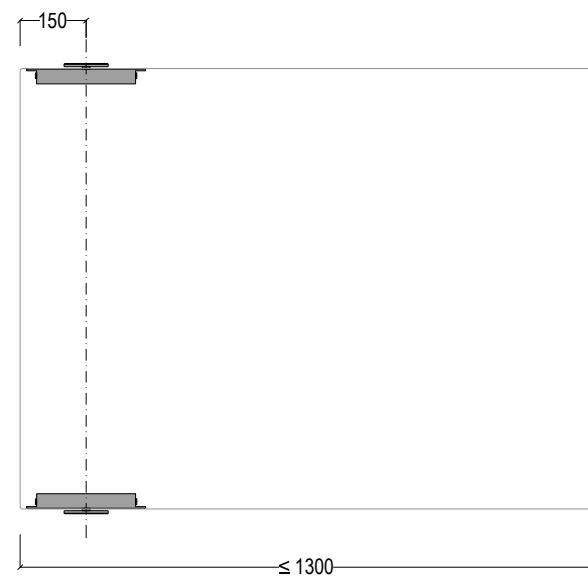

Cerniera porta a bilico e posizionamento sull'anta

_Pivot door's hinge and positioning on the door

Per dimensioni maggiori di 1300x3000 mm richiedere preventivo in azienda.
 _For dimensions bigger than 1300x3000 mm enquire the price to the company.



Maniglia incassata

_Recessed handle



_ LINEA VITRA / MANHATTAN

_ STIPITE CUBE / CUBE FRAME

_ SISTEMA PARETI / WALL SYSTEM

Un progetto incentrato su linee semplici ed essenziali di profili ridotti al minimo per offrire la possibilità di dialogare con lo spazio a 360°. Le pareti divisorie in vetro rappresentano una scelta di stile per delimitare le stanze, mantenendole spaziose e luminose, creando un rapporto sinergico tra gli ambienti e la luce portata dal vetro.

A design that focuses on simple, essential lines with profiles reduced to the minimum in order to offer the possibility of a 360° dialogue with the space. The glass partition walls represent a style choice to define rooms whilst keeping them spacious and light, creating a synergistic relationship between environments and the light brought by the glass.

STIPITE CUBE

_CUBE FRAME

Si tratta di uno stipite versatile che rappresenta la reinterpretazione ed evoluzione di ISY, un modello storico per HenryGlass, in un interessante progetto che coinvolge tecnica ed estetica.

Le proporzioni dei vari elementi che compongono lo stipite e la mancanza di cornici-coprifilo, consentono di realizzare progetti raffinati perfetti per svariate tipologie di funzione e di arredamento, ideali per creare atmosfere suggestive e conferire forte personalità all'ambiente. Cube è semplice da installare e progettato non solo come stipite singolo ma soprattutto per essere abbinato alle pareti fisse per andare a creare configurazioni personalizzate di suddivisione degli spazi.

This is a versatile frame that represents the re-interpretation and evolution of ISY, a historic model for HenryGlass, in an intriguing design that combines technique and aesthetics.

The proportions of the various elements that make up the frame and the lack of mouldings/covers, allow refined designs to be achieved, perfect for various types of functions and furnishings, ideal for creating suggestive settings and for adding a strong personality to the environment.

Cube is simple to install and was designed not only as a single frame but, above all, to be combined with fixed walls in order to create customised layouts of how to divide spaces.



Sezione stipite Cube installato
_Installed Cube frame section



Dettaglio tecnico stipite Cube
_Technical detail Cube frame



Manhattan_Scorrevole esterno muro Inside,
vetro trasparente, Grid 08, maniglia Square, finitura nero

Manhattan_Inside external wall sliding door, clear glass,
Grid 08, Square handle, black finish

Vitra_Porta a battente su stipite Cube, vetro satinato,
decoro Galuchat 01, maniglia Life, finitura nero

Vitra_Hinged door on Cube frame, frosted glass,
Galuchat 01 decoration, Life handle, black finish





Stipite Cube abbinato a porta a bilico Manhattan
 _Cube frame combined with Manhattan pivot door

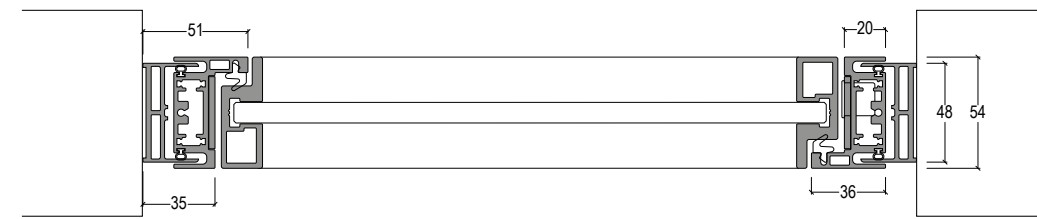

Porta a bilico Manhattan su stipite Cube
 _Pivot door Manhattan on Cube frame

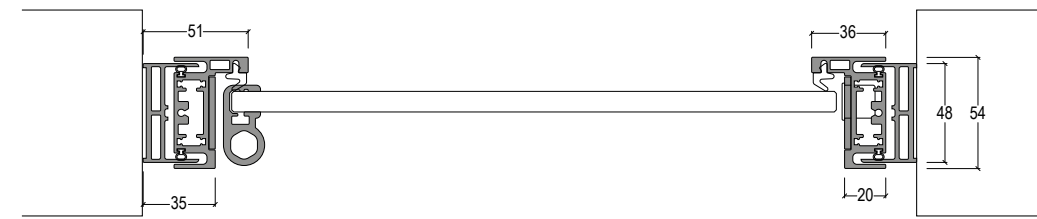

Porta a battente Vitra su stipite Cube
 _Hinged door Vitra on Cube frame

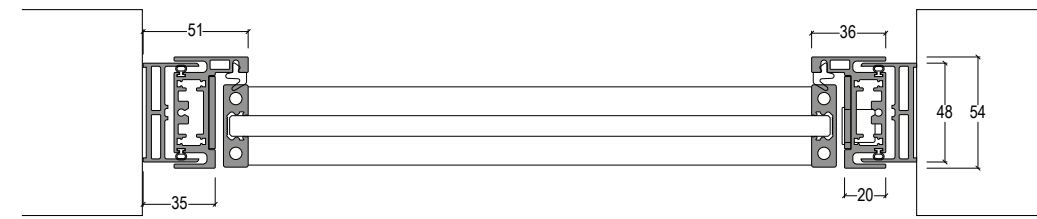

Porta a battente Manhattan su stipite Cube
 _Hinged door Manhattan on Cube frame

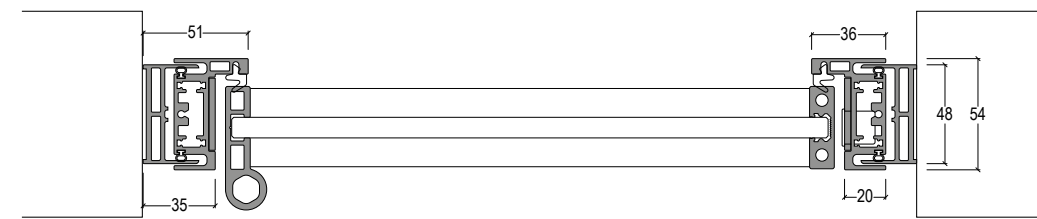

Porta a battente 180 su stipite Cube
 _Hinged door 180 on Cube frame

SISTEMA PARETI

_WALL SYSTEM

Un sistema di pareti divisorie ideale per la progettazione di ambienti contemporanei che rende il vetro protagonista grazie ad accorgimenti tecnici sofisticati e ad un'immagine d'insieme minimale. Porte a battente o a bilico, abbinata a vetrate fisse, disegnano lo spazio in composizioni lineari o più dinamiche - a seconda delle esigenze - e costituiscono un'occasione unica per immaginare gli spazi assecondandone volumi e geometrie. Un progetto personalizzabile e dalle molte configurazioni, sia per quanto riguarda la conformazione della parete divisoria sfruttando le diverse possibilità di apertura, sia per l'effetto del vetro che può essere più o meno coprente, extralight o colorato, arricchito da svariate tipologie di decorazioni. Lo stipite Cube risulta essere una componente essenziale di questo sistema divisorio, in quanto principale elemento di collegamento tra porte e pareti fisse.

A system of partition walls that are ideal for designing contemporary environments that make the glass the protagonist thanks to sophisticated technical features and an overall minimal impact. Swing doors or pivot doors, combined with fixed glass, design the space in linear or more dynamic compositions - depending on the needs - and constitute a unique opportunity to imagine spaces by fitting into their volumes and geometries. A customisable design with many configurations, both in terms of the layout of the partition wall, exploiting the various opening choices, and in terms of the effect of the glass, which can be more or less opaque, extralight or coloured, including with various types of decoration. The Cube frame is an essential component in this partition system since it is the main connecting element between the doors and the fixed walls.



Dettaglio profilo fermavetro 54 mm per vetrate fisse
_Detail of glazing bead profile for fixed glass panels 54 mm



Dettaglio tecnico profilo fermavetro 54 mm
_Technical detail of the glazing bead profile 54 mm





Manhattan _ Sistema pareti con vetri fissi e porte a bilico su stipite Cube, vetro trasparente, decoro Thai 02, maniglie Square, finitura moka

Manhattan _ Wall system with fixed glass and pivot doors on Cube frame, clear glass, Thai 02 decoration, Square handles, moka finish





Manhattan _Sistema pareti con vetri fissi e doppia porta a battente 180 su stipite Cube, vetro trasparente e satinato, decoro Ramiè, maniglia Life, finitura moka

Manhattan _Wall system with fixed glass and double swing doors 180 on Cube frame, clear and frosted glass, Ramiè decoration, Life handle, moka finish

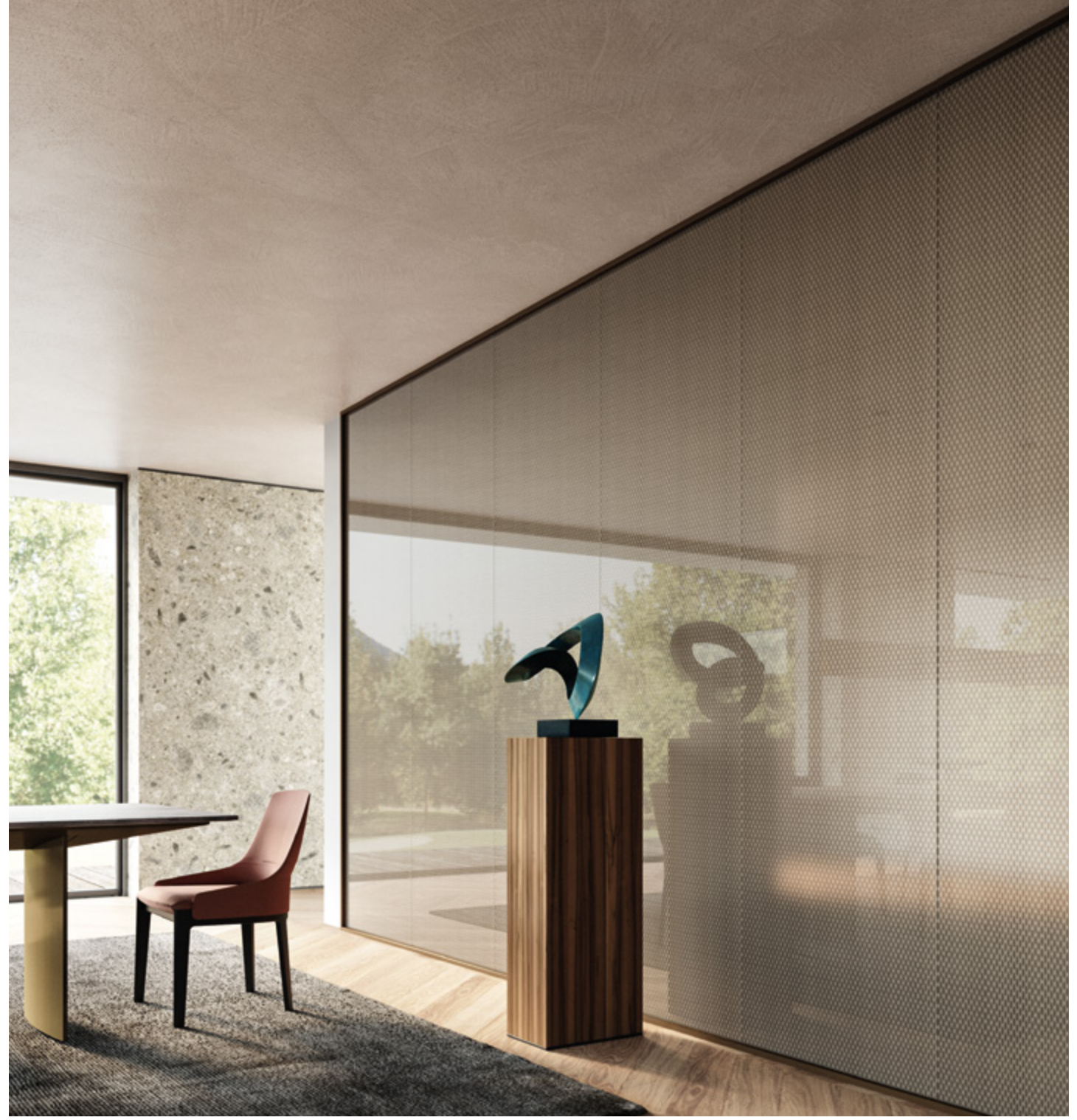

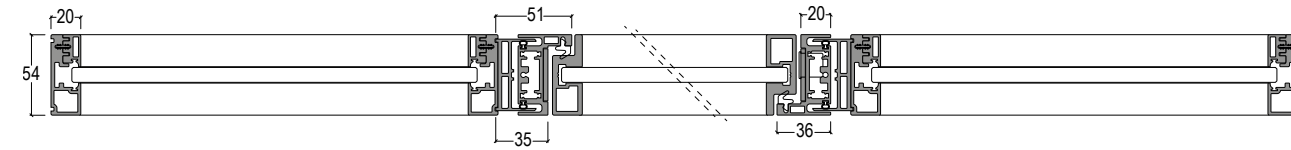

Stipite Cube abbinato a porta a bilico e vetrate fisse
_Cube frame combined with Pivot door and fixed glass panels

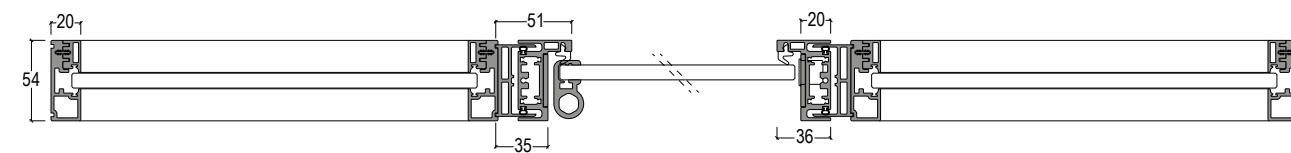

Stipite Cube abbinato a porta a battente Vitra e vetrate fisse
_Cube frame combined with Vitra Hinged door and fixed glass panels

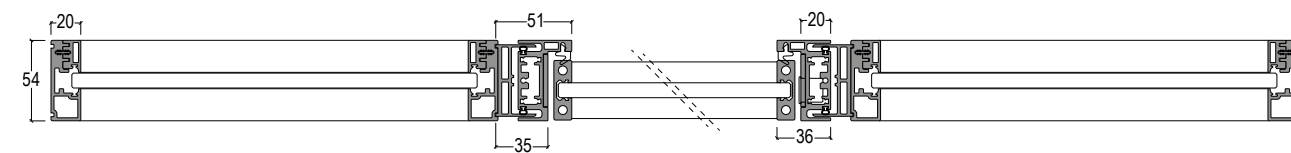

Stipite Cube abbinato a porta a battente Manhattan e vetrate fisse
_Cube frame combined with Manhattan Hinged door and fixed glass panels

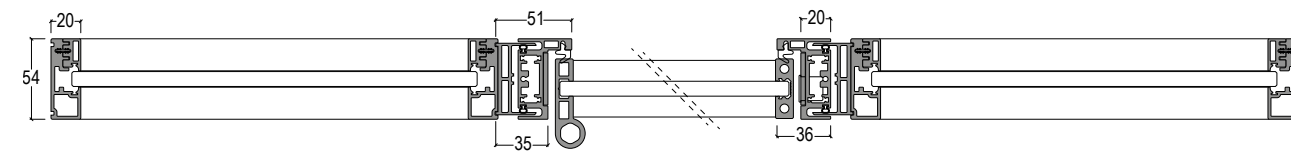

Stipite Cube abbinato a porta a battente 180 e vetrate fisse
_Cube frame combined with Hinged door 180 and fixed glass panels



Sezione del profilo fermavetro 54 mm per vetrate fisse
_Section of the glazing bead profile of fixed glass panels 54 mm



Sezione del profilo fermavetro 54 mm abbinato a stipite Cube per porte a battente o a bilico
_Section of the glazing bead profile 54 mm combined with Cube frame for swing or pivot doors

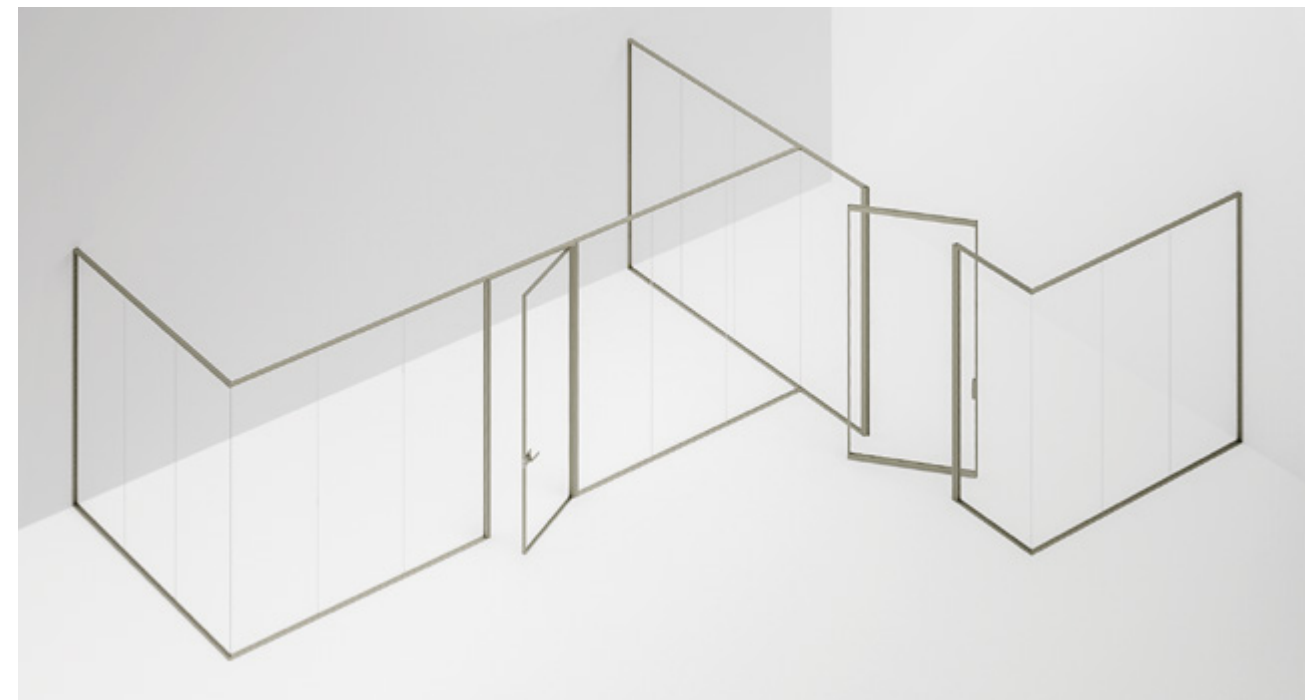

Sistema pareti: esempio di configurazione
_Wall system: configuration example

DECORI

_DECORATIONS

HenryGlass, sempre alla ricerca di nuove suggestioni per rinnovare le proprie collezioni, ha voluto trasferire sulle porte una serie di effetti decorativi tratti dalla natura che vogliono essere anche un omaggio all'unicità del sapere fare, dell'artigianalità di manufatti come per esempio la carta-paglia, la tappezzeria di pregio o la pittura a inchiostro giapponese che raccontano la stupefacente bellezza del fatto a mano.

HenryGlass, always open to new ideas to update its collections, wanted to transfer a series of decorative effects onto its doors. These effects, drawn from nature, are a tribute to a unique know-how, the artisanship seen in the items created such as, for example, the blotting paper, the fine tapestry or the Japanese ink painting that are testimony to the incredible beauty of items made by hand.

Quando la creatività progettuale e la conoscenza della materia di Nicola Gallizia si incontrano, possono nascere solo idee dal carattere inconfondibile e unico che, nello stile e nel design, rievocano l'autenticità imperfetta delle superfici naturali.

When Nicola Gallizia's design creativity and knowledge of materials meet, only ideas that have an unmistakable, unique character emerge, which, in terms of style and design, evoke the imperfect authenticity of natural surfaces.



WALLPAPER

_ HERITAGE

_ TWEED

_ ORIGIN

_ OPEN UP

Una collezione di decori dall'impronta nobile che rimandano ad antichi splendori. Come in un fondale di teatro, carta da parati e vetro mettono in scena composizioni caratterizzate da un forte ardore decorativo. In un equilibrio perfetto, sulla superficie verticale della parete si inseguono forme geometriche, colori e simmetrie a generare un gioco grafico esclusivo e dall'inconfondibile bellezza.

A collection of decorations bearing a fine print that recall ancient splendour. As in the theatre's backdrop, wallpaper and glass become the stage for compositions characterised by a strong, decorative passion. In perfect balance, on the vertical surface of the wall, geometric shapes, colours and symmetries chase each other in an exclusive, graphic game of unmistakable beauty.

_HERITAGE

Rarità e pregio trovano espressione in questo decoro dal segno vigoroso e leggero allo stesso tempo. Spigolose geometrie dal tratto profondo e distintivo vengono sfoggiate in un sapiente accostamento di cromie.

Il decoro è disponibile in tre varianti di colore per creare stili diversi ma sempre inconfondibili. A seconda delle esigenze, può essere realizzato su vetro extralight trasparente, per un effetto leggero e discreto, oppure su vetro extralight satinato, per un contrasto cromatico più intenso e deciso.

Per valorizzare stili e spazi e conferire ancora più carattere agli ambienti, è possibile progettare le pareti circostanti alle porte con lo stesso decoro Heritage che può essere quindi riprodotto su carta da parati e applicato in continuità rispetto alla porta.

Rarity and value find an outlet in this decoration with a strong yet light touch. Angular geometries with deep, distinctive lines are flaunted in a skilful combination of colours.

The decoration is available in three colours to create various - but always unmistakable - styles. Depending on the needs, it can be made on clear, extra-light glass, for a light, discrete effect, or on frosted, extralight glass, for a more intensive and decisive chromatic contrast.

To enhance styles and spaces and to give even more character to environments, the walls surrounding the doors can be designed with the same Heritage decoration that can, therefore, be reproduced on wallpaper and applied in a continuous way with regard to the door.



Porta decorata
_Decorated door



Porta decorata abbinata alla carta da parati
_Decorated door combined with the wallpaper

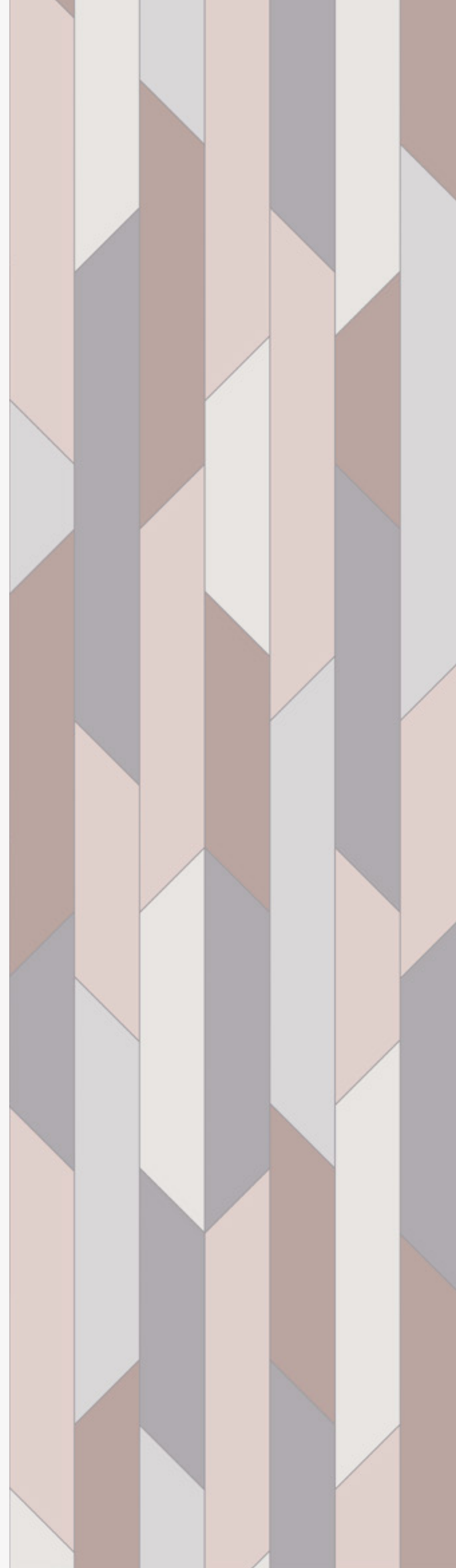

HERITAGE_01



Tecnica: Impressioni CAT. A
Technique: Impressions CAT. A



Vetro trasparente extralight
Extralight clear glass



Vetro satinato extralight
Extralight frosted glass



HERITAGE_01
cod. W101



WALLPAPER

HERITAGE_02



Tecnica: Impressioni CAT. A
Technique: Impressions CAT. A



Vetro trasparente extralight
Extralight clear glass



Vetro satinato extralight
Extralight frosted glass



HERITAGE_02
cod. W102

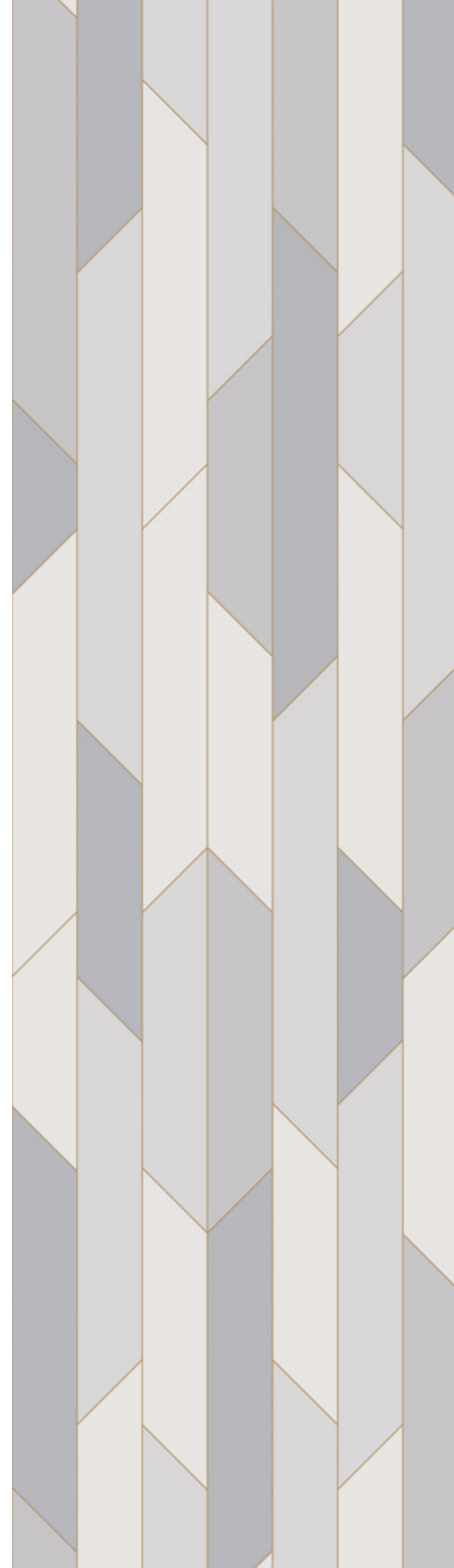

HERITAGE

HERITAGE_03



Tecnica: Impressioni CAT. A
Technique: Impressions CAT. A



Vetro trasparente extralight
Extralight clear glass



Vetro satinato extralight
Extralight frosted glass



HERITAGE_03
cod. W103



Manhattan - Scorrevoli a scomparsa senza stipite, vetro satinato, decoro Heritage 02, maniglie Avenue, finitura nero, carta da parati Heritage 02

Manhattan - Pocket sliding doors without frame, frosted glass, Heritage 02 decoration, Avenue handles, black finish, Heritage wallpaper 02

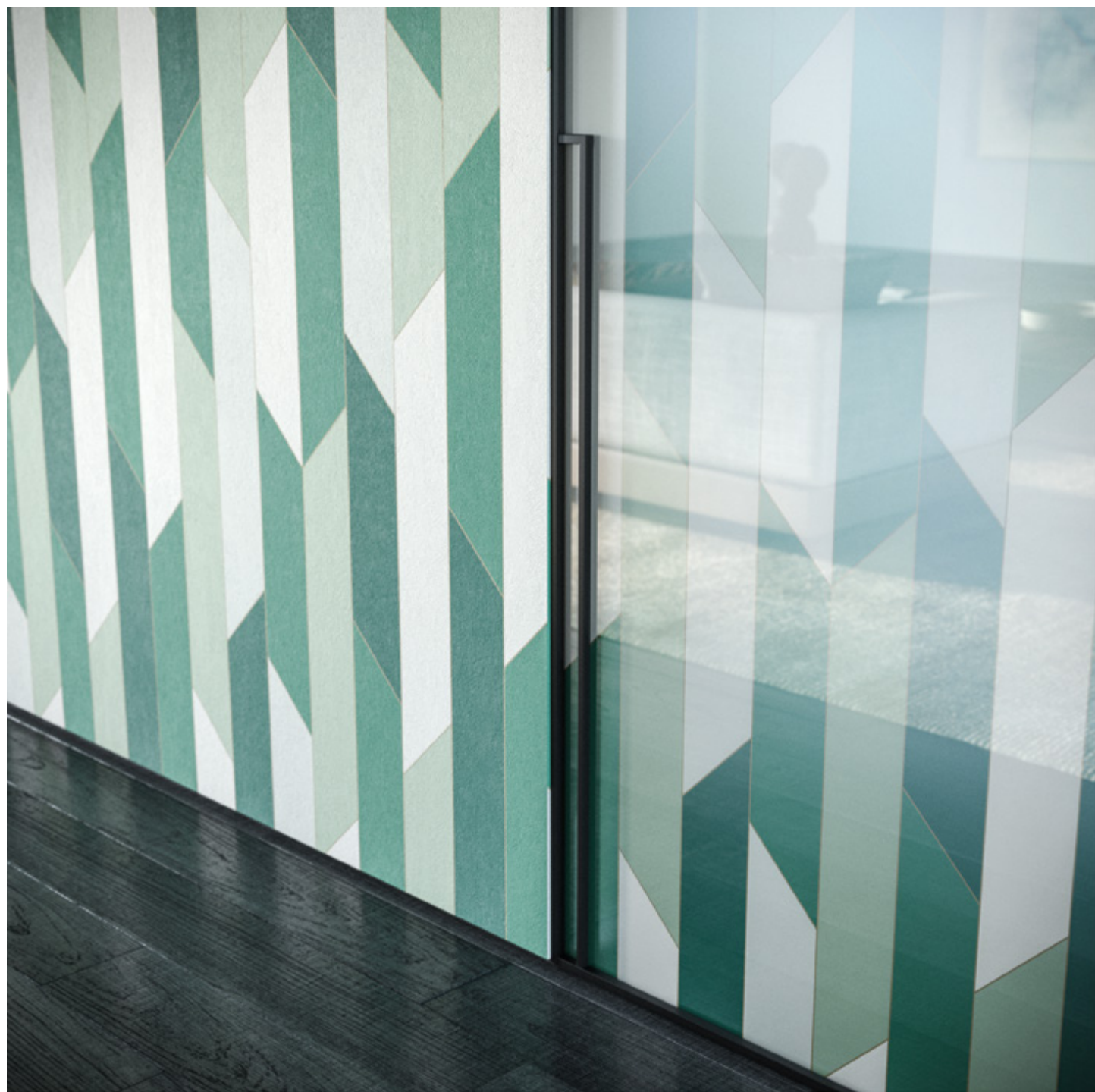

_TWEED

Un disegno prezioso, caratterizzato da una grafica tridimensionale con un chiaro rimando al mondo dei tessuti di pregio. In un'alternanza di pieni e di vuoti, questa decorazione è in grado di creare un continuum cromatico ed estetico che pare senza un inizio e senza una fine.

Il decoro è disponibile in tre varianti di colore per creare stili diversi ma sempre inconfondibili. A seconda delle esigenze, può essere realizzato su vetro extralight trasparente, per un effetto leggero e discreto, oppure su vetro extralight satinato, per un contrasto cromatico più intenso e deciso.

Per valorizzare stili e spazi e conferire ancora più carattere agli ambienti, è possibile progettare le pareti circostanti alle porte con lo stesso decoro Tweed che può essere quindi riprodotto su carta da parati e applicato in continuità rispetto alla porta.



Porta decorata
_Decorated door

INTRO

A classic design, featuring three-dimensional graphics with a clear reference to the world of fine fabrics. Alternating solid and empty, this decoration is able to create a chromatic, aesthetic continuum that seems without beginning and without end.

The decoration is available in three colours to create various - but always unmistakable - styles. Depending on the needs, it can be made on clear extra-light glass, for a light, discrete effect, or on frosted extra-light glass, for a more intensive and decisive chromatic contrast. To enhance styles and spaces and to give even more character to environments, the walls surrounding the doors can be designed with the same Tweed decoration that can, therefore, be reproduced on wallpaper and applied in a continuous way with regard to the door.



Porta decorata abbinata alla carta da parati
_Decorated door combined with the wallpaper



TWEED_01



Tecnica: Impressioni CAT. A
Technique: Impressions CAT. A



Vetro trasparente extralight
Extralight clear glass



Vetro satinato extralight
Extralight frosted glass



TWEED_01
cod. W111



WALLPAPER

TWEED_02



Tecnica: Impressioni CAT. A
Technique: Impressions CAT. A



Vetro trasparente extralight
Extralight clear glass



Vetro satinato extralight
Extralight frosted glass



TWEED_02
cod. W112



TWEED

TWEED_03



Tecnica: Impressioni CAT. A
Technique: Impressions CAT. A



Vetro trasparente extralight
Extralight clear glass



Vetro satinato extralight
Extralight frosted glass



TWEED_03
cod. W113



Manhattan _Porte a bilico, vetro satinato, decoro Tweed 03, maniglie Square, finitura nero; carta da parati Tweed 03

Manhattan _Pivot doors, frosted glass, Tweed 03 decoration, Square handles, black finish, Tweed wallpaper 03

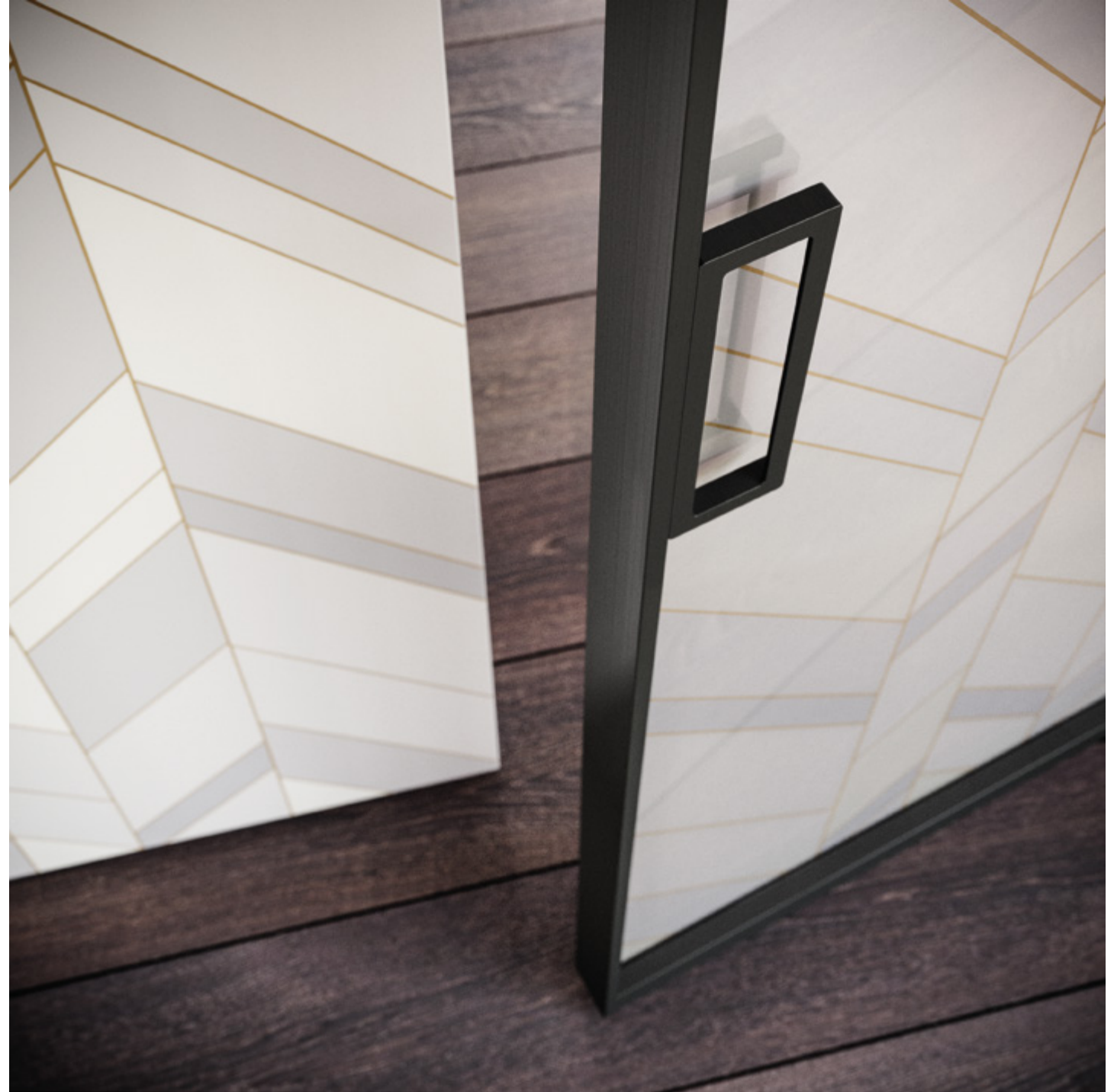

_ORIGIN

Forme geometriche solide e imponenti incontrano la bellezza del colore: un decoro dalle superfici mutevoli che paiono dialogare con chi guarda per trasformare con eleganza la personalità dell'ambiente. Il decoro è disponibile in tre varianti di colore per creare stili diversi ma sempre inconfondibili.

A seconda delle esigenze, può essere realizzato su vetro extralight trasparente, per un effetto leggero e discreto, oppure su vetro extralight satinato, per un contrasto cromatico più intenso e deciso. Per valorizzare stili e spazi e conferire ancora più carattere agli ambienti, è possibile progettare le pareti circostanti alle porte con lo stesso decoro Origin che può essere quindi riprodotto su carta da parati e applicato in continuità rispetto alla porta.



Porta decorata
_Decorated door

Solid, impressive geometric forms meet the beauty of colour: a decoration with changing surfaces that seem to communicate with the viewer to transform the environment's personality with elegance. The decoration is available in three colours to create various - but always unmistakable - styles.

Depending on the needs, it can be made on clear extra-light glass, for a light, discrete effect, or on frosted extralight glass, for a more intensive and decisive chromatic contrast. To enhance styles and spaces and to give even more character to environments, the walls surrounding the doors can be designed with the same Origin decoration that can, therefore, be reproduced on wallpaper and applied in a continuous way with regard to the door.



Porta decorata abbinata alla carta da parati
_Decorated door combined with the wallpaper



ORIGIN_01



Tecnica: Impressioni CAT. A
Technique: Impressioni CAT. A



Vetro trasparente extralight
Extralight clear glass



Vetro satinato extralight
Extralight frosted glass



ORIGIN_01
cod. W121



WALLPAPER

ORIGIN_02



Tecnica: Impressioni CAT. A
Technique: Impressions CAT. A



Vetro trasparente extralight
Extralight clear glass



Vetro satinato extralight
Extralight frosted glass

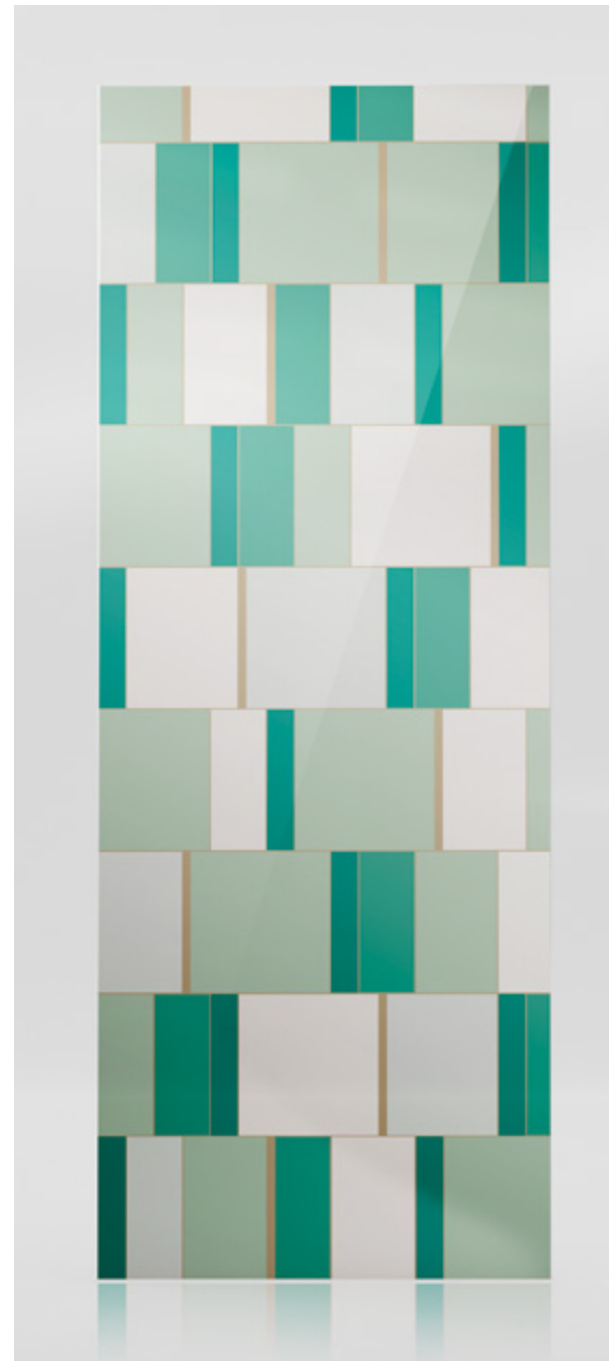

ORIGIN_02
cod. W122

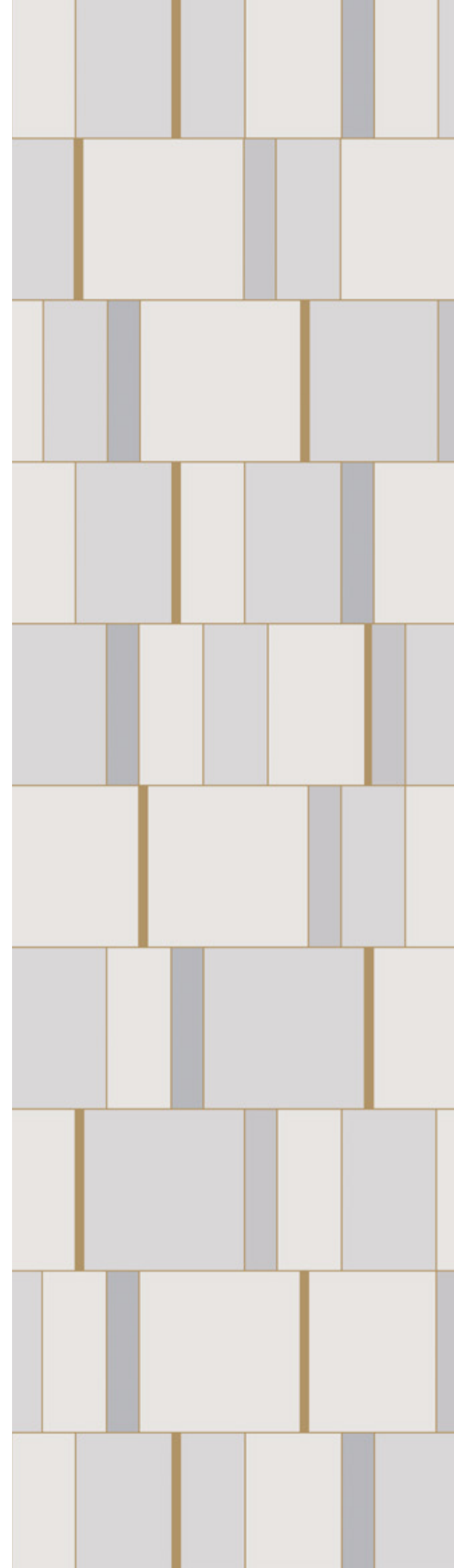

ORIGIN

ORIGIN_03



Tecnica: Impressioni CAT. A
Technique: Impressions CAT. A



Vetro trasparente extralight
Extralight clear glass



Vetro satinato extralight
Extralight frosted glass



ORIGIN_03
cod. W123



Manhattan _Scorrevoli esterno muro Inside, vetro satinato, decoro Origin 01, maniglia Square e maniglia Avenue, finitura Ottone; carta da parati Origin 01

Manhattan _Inside external wall sliding doors, frosted glass, Origin 01 decoration, Square handle and Avenue handle, Brass finish; Origin 01 wallpaper



_OPEN UP

Forme minimali da accarezzare con gli occhi per questa decorazione che parla un linguaggio fatto di giochi prospettici e vibranti simmetrie accuratamente connesse tra loro per generare atmosfere armoniose. Il decoro è disponibile in due modelli e tre varianti di colore per creare stili diversi ma sempre inconfondibili.

A seconda delle esigenze, può essere realizzato su vetro extralight trasparente, per un effetto leggero e discreto, oppure su vetro extralight satinato, per un contrasto cromatico più intenso e deciso. Per valorizzare stili e spazi e conferire ancora più carattere agli ambienti, è possibile progettare le pareti circostanti alle porte con lo stesso decoro Open up che può essere quindi riprodotto su carta da parati e applicato in continuità rispetto alla porta.

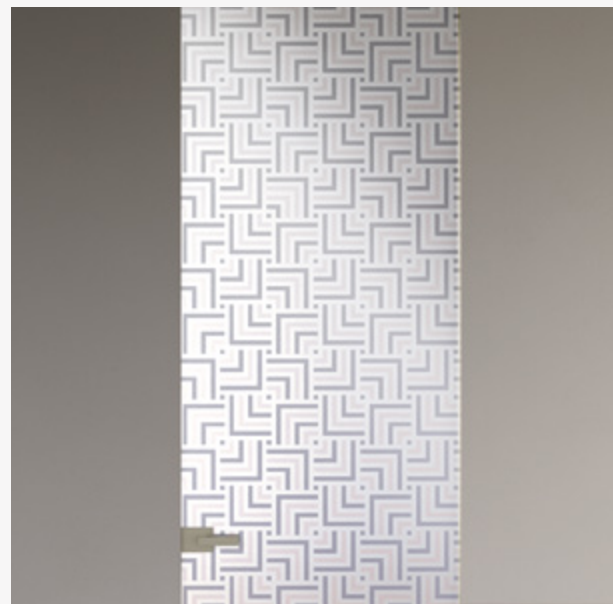

Porta decorata
_Decorated door

Minimal shapes to be enjoyed with the eyes, for this decoration that speaks a language made of perspective games and vibrant symmetries, carefully connected to each other to generate harmonious atmospheres. The decoration is available in two patterns and three colours to create various - but always unmistakable - styles.

Depending on the needs, it can be made on clear extra-light glass, for a light, discrete effect, or on frosted extralight glass, for a more intensive and decisive chromatic contrast. To enhance styles and spaces and to give even more character to environments, the walls surrounding the doors can be designed with the same Open up decoration that can, therefore, be reproduced on wallpaper and applied in a continuous way with regard to the door.

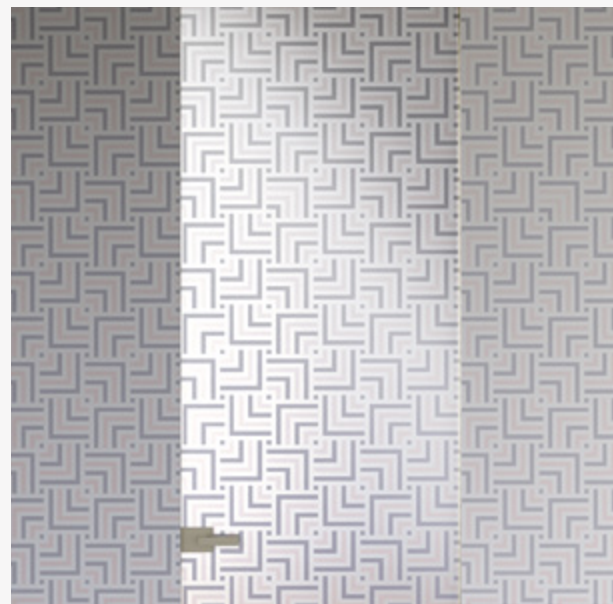

Porta decorata abbinata alla carta da parati
_Decorated door combined with the wallpaper

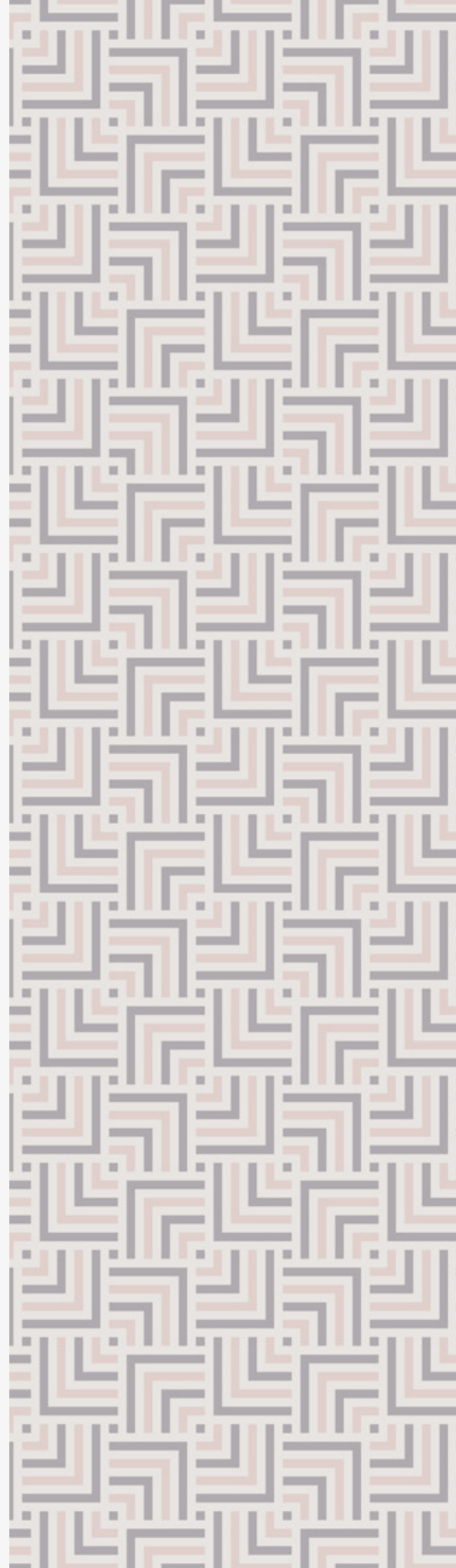

OPEN UP_01



Tecnica: Impressioni CAT. A
Technique: Impressions CAT. A



Vetro trasparente extralight
Extralight clear glass



Vetro satinato extralight
Extralight frosted glass



OPEN UP_01
cod. W131

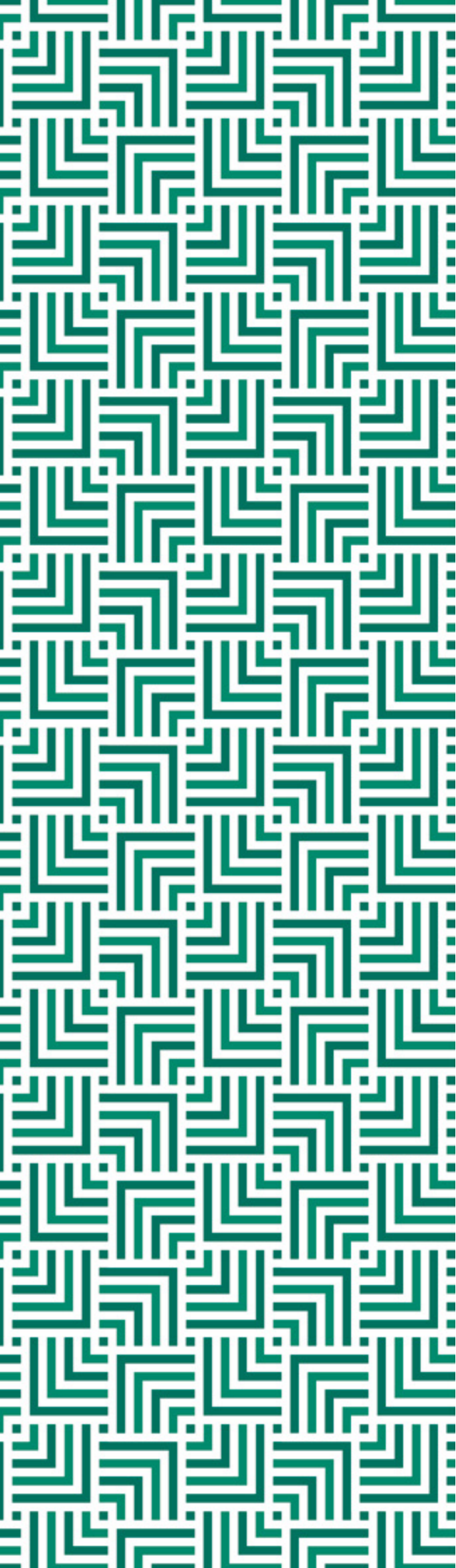

WALLPAPER

OPEN UP_02



Tecnica: Impressioni CAT. A
Technique: Impressions CAT. A



Vetro trasparente extralight
Extralight clear glass



Vetro satinato extralight
Extralight frosted glass

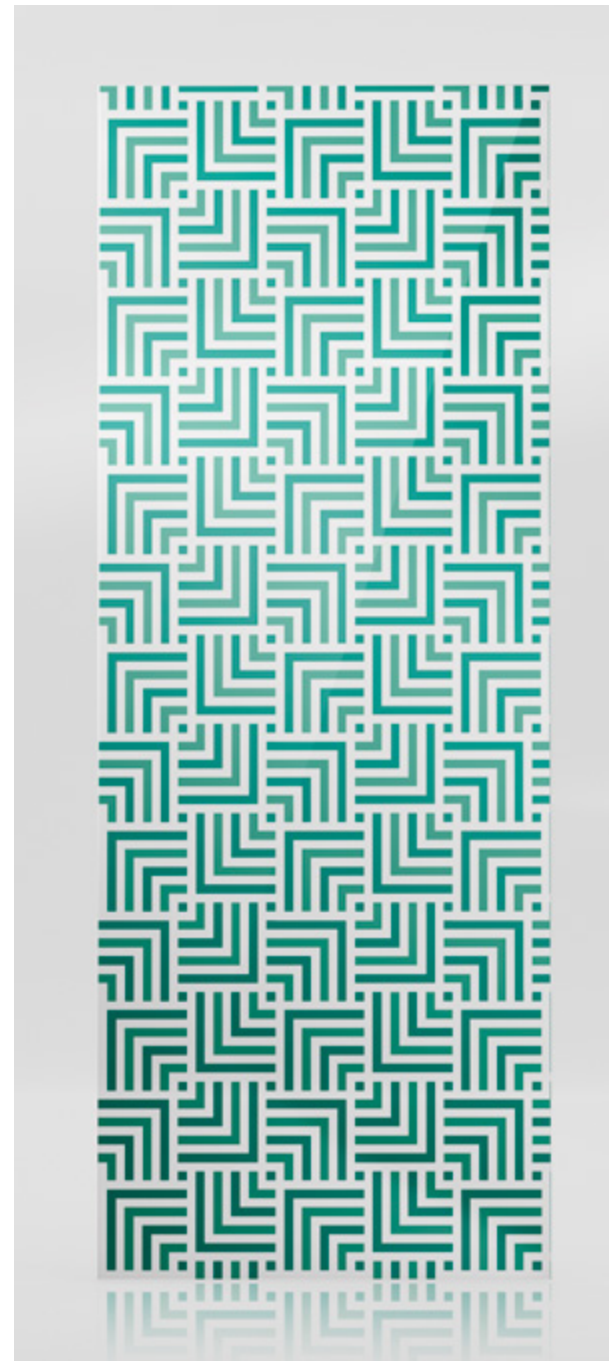

OPEN UP_02
cod. W132

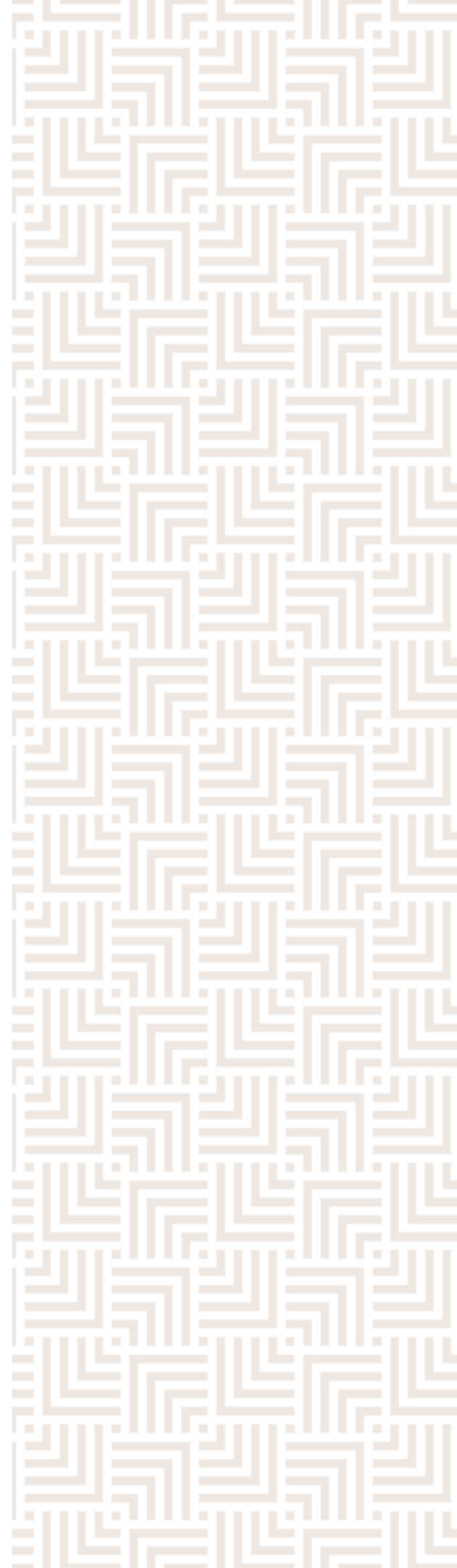

OPEN UP

OPEN UP_03



Tecnica: Impressioni CAT. A
Technique: Impressions CAT. A



Vetro trasparente extralight
Extralight clear glass



Vetro satinato extralight
Extralight frosted glass



OPEN UP_03
cod. W133



Adela _Porte a bilico grezze trattate come la parete, maniglie incassate; carta da parati Open up 03

Adela _Raw pivot doors treated like the wall, recessed handles; Open up 03 wallpaper

Manhattan _Porta a battente su stipite Plain, vetro satinato, decoro Open up 03, maniglia Life, finitura moka

Manhattan _Hinged door on Plain frame, frosted glass, Open up 03 decoration, Life handle, moka finish



CARTA DA PARATI PER INTERNI

_INTERIORS WALLPAPER

La carta da parati proposta da HenryGlass, conciliando praticità ed estetica, è la perfetta soluzione per personalizzare gli ambienti domestici con stile. Si tratta un rivestimento murale vinilico con supporto tessuto-non tessuto che presenta una superficie gofrata e irregolare che ricorda la superficie di una tela. La texture ne esalta il disegno e lo rende tattile.

Adatto esclusivamente agli ambienti interni (parete / soffitto), resiste agli urti ed è di facile manutenzione.

Viene fornito in rotoli da 1000 x 6000 mm (bxh)

_Supplied in 1000 x 6000 mm rolls

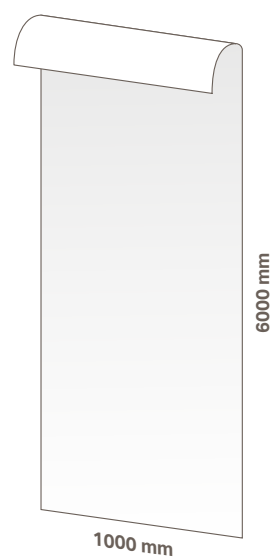
**DETTAGLI TECNICI**

The wallpaper proposed by HenryGlass, combining practicality and aesthetics, it is the perfect solution to customize domestic environments with style.

This is a vinyl wall covering with non-woven backing that has an embossed surface, irregular surface that resembles a canvas. The texture enhances the design with a tactile feel.

Suitable for indoor application only (wall / ceiling), it is resistant to impacts and easy to maintain.

Materiale:

_Material:

Tessuto non tessuto

_Non-woven fabric

(70% cellulosa - 20% fibre sintetiche - 8% additivi)

_(70% cellulose - 20% synthetic fibre - 8% additives)

Spalmatura del lato decorativo p.v.c. 100% di cui 4% componenti ignifuganti

_100% PVC spread on the decorative side of wich 4% flameproof components

Peso totale (-/+): 380 g/m²

_Total weight (-/+): 380 g/m²

Spessore totale (-/+): 0,34 mm

_Total thickness (-/+): 0,34 mm

Certificazione reazione al fuoco: Classe B-s2, dO - USA Classe A

_Fire reaction certification: Class B-s2, dO - USA Class A



Resistenza agli urti
_Impact resistant



Ignifugo
_Fire proof



Superficie gofrata
_Embossed surface



Applicazione con colla
_Application with glue



Lavabile
_Washable



Rimovibile a secco
_Removable



_OLTRE LA MATERIA

_ GALUCHAT

_ THAI

_ SHODO

_ RAMIÈ

_ GREY PLASTER

L'impalpabile tramatura della pelle, la magia dei tessuti orientali, le leggerezze delle carte giapponesi...

Matrici che sono scritte nella cultura di popoli lontani in grado di generare contaminazioni e contrasti racchiusi in un percorso sensoriale - su progetto di Nicola Gallizia - nato per conferire nuova identità a porte e pareti.

The impalpable texture of leather, the magic of Oriental fabrics, the lightness of Japanese paper... Aspects which are written into the cultures of distant people and which are capable of generating blends and contrasts enclosed in a sensory journey - designed by Nicola Gallizia - created to give a new identity to doors and walls.

_GALUCHAT

Un reticolo di guizzi dalla pigmentazione delicata solcano la superficie del vetro e sembrano cambiare continuamente alla vista con nuove forme e sfumature. La struttura concentrica evoca la sensuale morbidezza della pelle di razza da cui trae origine il decoro, in una trama mutevole e raffinata.

Il decoro è disponibile in tre varianti di colore per creare stili diversi ma sempre inconfondibili. Può impreziosire tutte le tipologie di porte HenryGlass, anche vetrate fisse.

A seconda delle esigenze, può essere realizzato su vetro extralight trasparente, per un effetto leggero e discreto, oppure su vetro extralight satinato, per un contrasto cromatico più intenso e deciso.

A lattice of delicately pigmented flashes which furrow the glass surface and which seem to constantly change to the eye with new shapes and shades. The concentric structure evokes the sensual softness of pedigree leather from which the decoration originates, in a changing, refined texture.

The decoration is available in three colours to create various - but always unmistakable - styles. It can embellish any type of HenryGlass door, including fixed glass.

Depending on the needs, it can be made on clear extra-light glass, for a light, discrete effect, or on frosted extralight glass, for a more intensive and decisive chromatic contrast.



GALUCHAT_01



Tecnica: Impressioni CAT. B
Technique: Impressions CAT. B



Vetro trasparente extralight
Extralight clear glass



Vetro satinato extralight
Extralight frosted glass



GALUCHAT_01
cod. M501

GALUCHAT_02



Tecnica: Impressioni CAT. B
Technique: Impressions CAT. B



Vetro trasparente extralight
Extralight clear glass



Vetro satinato extralight
Extralight frosted glass



GALUCHAT_02
cod. M502

GALUCHAT_03



Tecnica: Impressioni CAT. B
Technique: Impressions CAT. B



Vetro trasparente extralight
Extralight clear glass



Vetro satinato extralight
Extralight frosted glass



GALUCHAT_03
cod. M503

_SHODO

Tracce parallele leggermente irregolari disegnate con un pennello da mani esperte, creano un intreccio di rigore e imprevedibilità. Shodo, che letteralmente significa "Via della scrittura", rappresenta un vero e proprio percorso interiore che coniuga la padronanza del pennello con la padronanza del sé.

Il decoro è disponibile in tre varianti di colore per creare stili diversi ma sempre inconfondibili. Può impreziosire tutte le tipologie di porte HenryGlass, anche vetrate fisse. A seconda delle esigenze, può essere realizzato su vetro extralight trasparente, per un effetto leggero e discreto, oppure su vetro extralight satinato, per un contrasto cromatico più intenso e deciso.

Slightly irregular, parallel traces drawn with a brush wielded by expert hands, they create an intertwining rigour and unpredictability. Shodo, which literally means "the way of writing", represents a real inner journey that combines the mastery of the brush with the mastery of the self.

The decoration is available in three colours to create various - but always unmistakable - styles. It can embellish any type of HenryGlass door, including fixed glass.

Depending on the needs, it can be made on clear extra-light glass, for a light, discrete effect, or on frosted extralight glass, for a more intensive and decisive chromatic contrast.

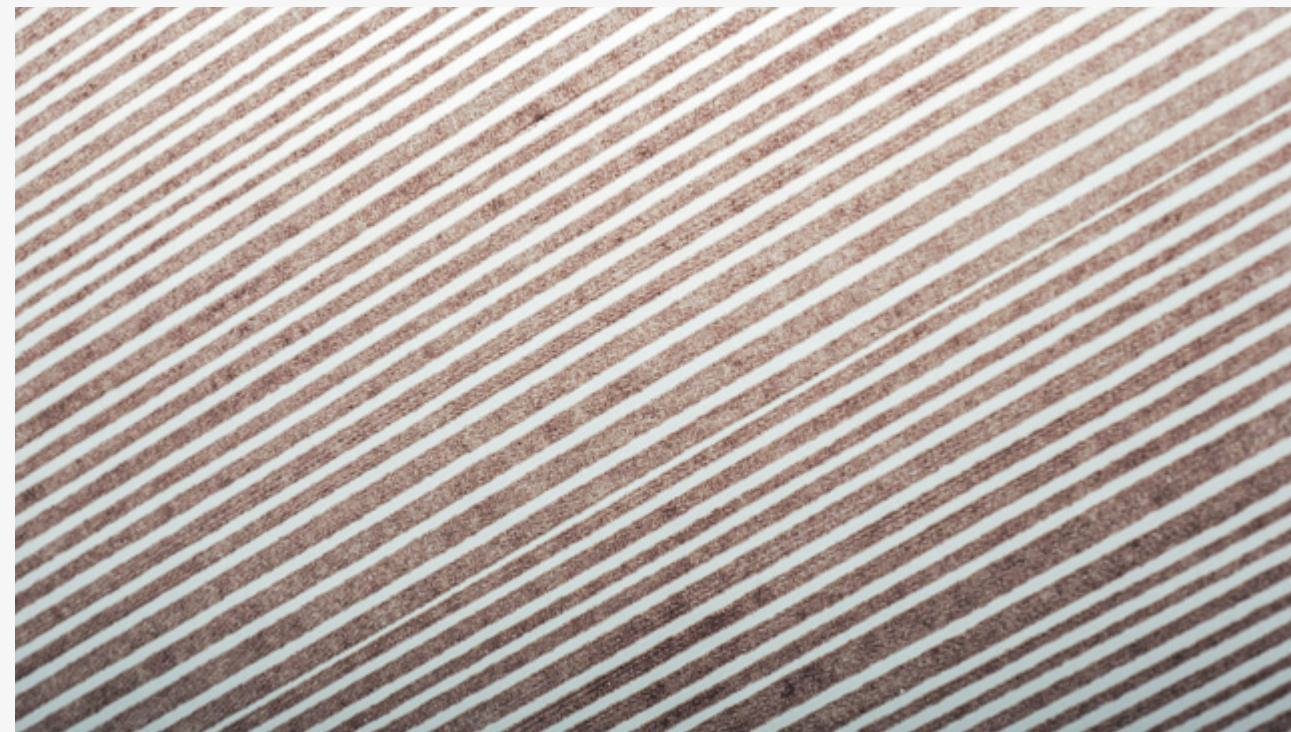

SHODO_01



Tecnica: Impressioni CAT. B
Technique: Impressions CAT. B



Vetro trasparente extralight
Extralight clear glass



Vetro satinato extralight
Extralight frosted glass



SHODO_01
cod. M511

SHODO_02



Tecnica: Impressioni CAT. B
Technique: Impressions CAT. B



Vetro trasparente extralight
Extralight clear glass



Vetro satinato extralight
Extralight frosted glass



SHODO_02
cod. M512

SHODO_03



Tecnica: Impressioni CAT. B
Technique: Impressions CAT. B



Vetro trasparente extralight
Extralight clear glass



Vetro satinato extralight
Extralight frosted glass



SHODO_03
cod. M513

_THAI

Un abile intreccio di filamenti vegetali esprime il suo fascino di naturalezza attraverso l'irregolarità dei toni e delle trame evocando paesi e tradizioni lontane. La fedeltà dei dettagli, come le piccole imperfezioni del filato, non fa che esaltare la raffinatezza della texture e il fascino del fatto a mano.

Il decoro è disponibile in tre varianti di colore per creare stili diversi ma sempre inconfondibili. Può impreziosire tutte le tipologie di porte HenryGlass, anche vetrate fisse.

A seconda delle esigenze, può essere realizzato su vetro extralight trasparente, per un effetto leggero e discreto, oppure su vetro extralight satinato, per un contrasto cromatico più intenso e deciso.

A skilful interweaving of plant fibres expresses its natural charm through tones and textures that evoke distant countries and traditions.

The devotion to the details, such as the tiny imperfections in the thread, only enhances the fineness of the texture and the charm of an item made by hand.

The decoration is available in three colours to create various - but always unmistakable - styles. It can embellish any type of HenryGlass door, including fixed glass.

Depending on the needs, it can be made on clear extra-light glass, for a light, discrete effect, or on frosted extralight glass, for a more intensive and decisive chromatic contrast.

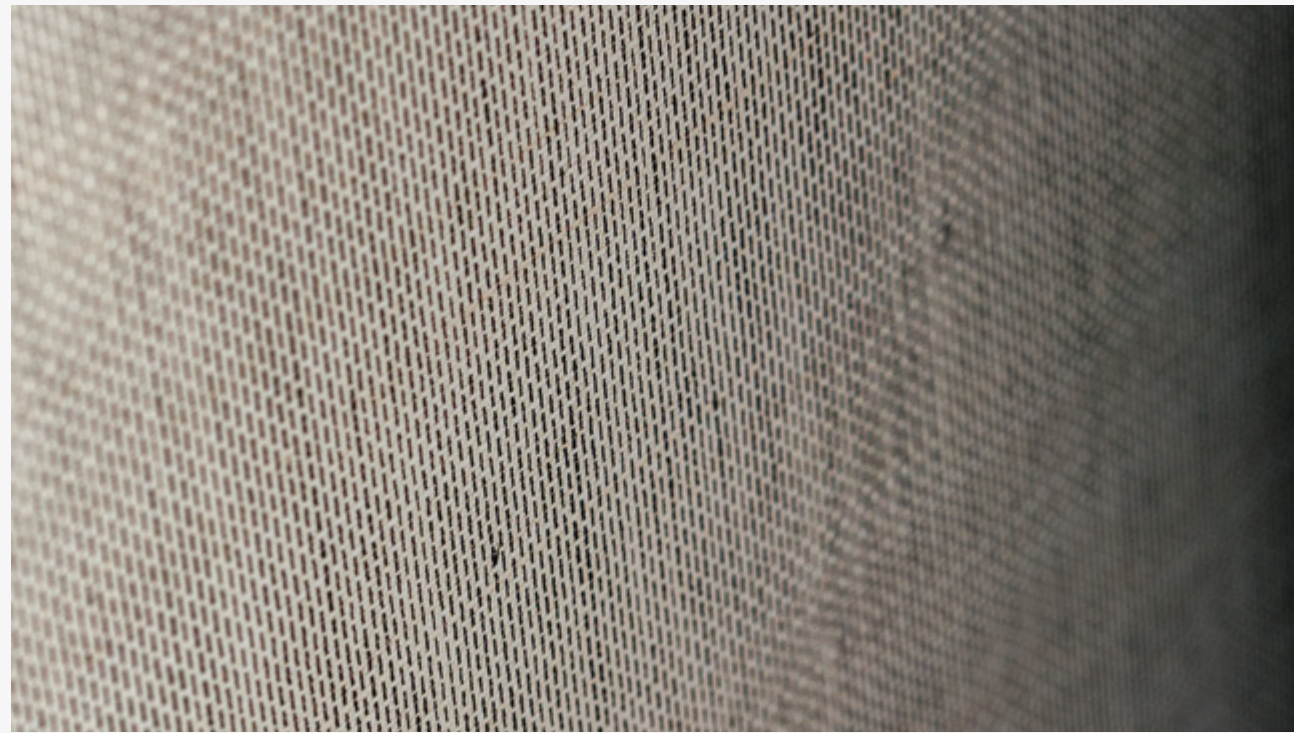

THAI_01



Tecnica: Impressioni CAT. B
Technique: Impressions CAT. B



Vetro trasparente extralight
Extralight clear glass



Vetro satinato extralight
Extralight frosted glass



THAI_01
cod. M521

THAI_02



Tecnica: Impressioni CAT. B
Technique: Impressions CAT. B



Vetro trasparente extralight
Extralight clear glass



Vetro satinato extralight
Extralight frosted glass



THAI_02
cod. M522

THAI_03



Tecnica: Impressioni CAT. B
Technique: Impressions CAT. B



Vetro trasparente extralight
Extralight clear glass



Vetro satinato extralight
Extralight frosted glass



THAI_03
cod. M523

_RAMIÈ

Un decoro che aspira a comunicare tutto il pregio della tradizione manifatturiera del settore tessile. Un grafismo semplice ma dal forte impatto estetico, in grado di impreziosire gli ambienti con la sua texture morbida e raffinata per rendere unico ogni spazio.

Il decoro è disponibile in un'unica variante di colore e può impreziosire tutte le tipologie di porte HenryGlass, anche vetrate fisse. A seconda delle esigenze, può essere realizzato su vetro extralight trasparente, per un effetto leggero e discreto, oppure su vetro extralight satinato, per un contrasto cromatico più intenso e deciso.

A decoration that aspires to communicate all the value of manufacturing tradition in the textile sector. A simple graphic design technique but with a strong aesthetic impact, capable of embellishing environments with its soft, refined texture to make any space unique.

The decoration is available in a single colour and can embellish any type of HenryGlass door, including fixed glass. Depending on the needs, it can be made on clear extra-light glass, for a light, discrete effect, or on frosted extralight glass, for a more intensive and decisive chromatic contrast.



RAMIÈ_01



Tecnica: Impressioni CAT. B
Technique: Impressions CAT. B



Vetro trasparente extralight
Extralight clear glass



Vetro satinato extralight
Extralight frosted glass

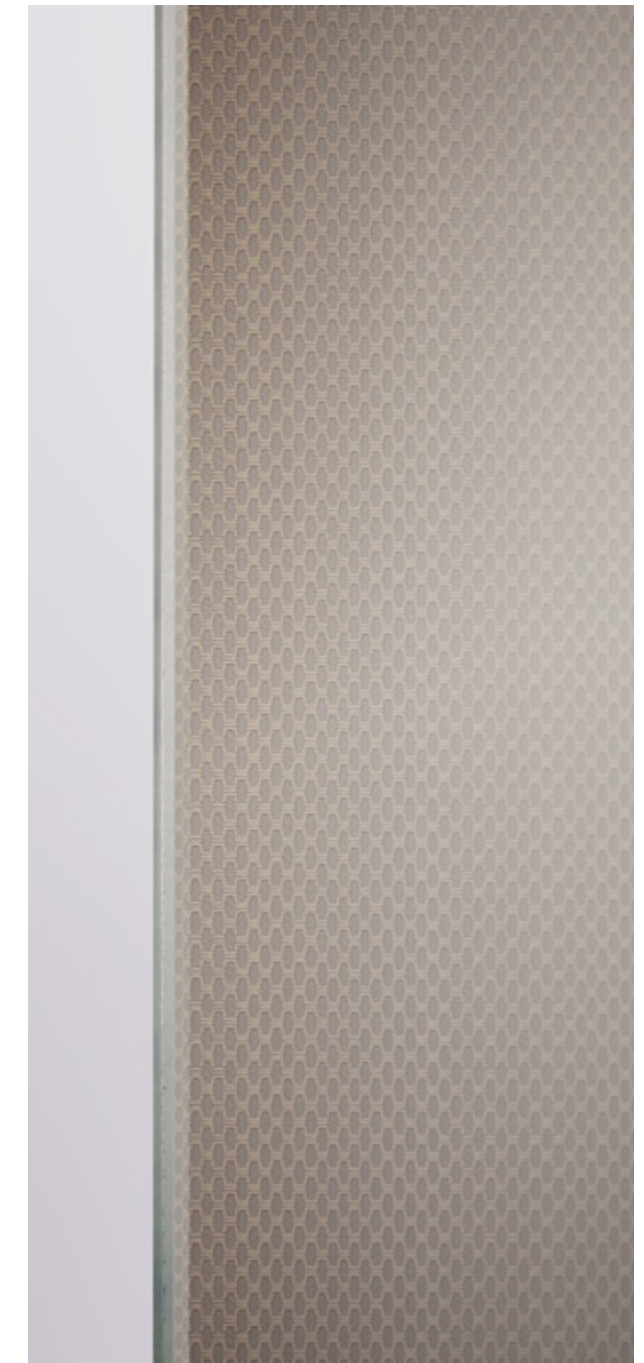

RAMIÈ_01
cod. M531

_GREY PLASTER

Da Le Corbusier fino ai nostri giorni, il cemento è un materiale ricco di significati, simbolo di modernità e oggi molto apprezzato dagli interior designer proprio per la rinnovata sensibilità nei confronti dello stile urban. Il vetro effetto-cemento, affascinante e ricco di personalità per quanto discreto, è ideale in progetti dal grande impatto contenutistico, per creare atmosfere moderne e al contempo avvolgenti.

Il decoro può impreziosire tutte le tipologie di porte HenryGlass, anche vetrate fisse. A seconda delle esigenze, può essere realizzato su vetro extralight trasparente, per un effetto leggero e discreto, oppure su vetro extralight satinato, per un contrasto cromatico più intenso e deciso.



Since Le Corbusier until nowadays, cement is a material rich of meanings, symbol of modernity and today is very much appreciated by interior designers, because of this particular innovated sense towards the urban style. The glass with the cement effect, charming and rich of personality, but at the same time discreet, it's ideal of project with a great impact of content, to create modern and at the same time, cozy atmosphere.

The decoration can embellish any type of HenryGlass door, including fixed glass. Depending on the needs, it can be made on clear extra-light glass, for a light, discrete effect, or on frosted extralight glass, for a more intensive and decisive chromatic contrast.

GREY PLASTER



Tecnica: Impressioni CAT. B
Technique: Impressions CAT. B



Vetro trasparente extralight
Extralight clear glass



Vetro satinato extralight
Extralight frosted glass

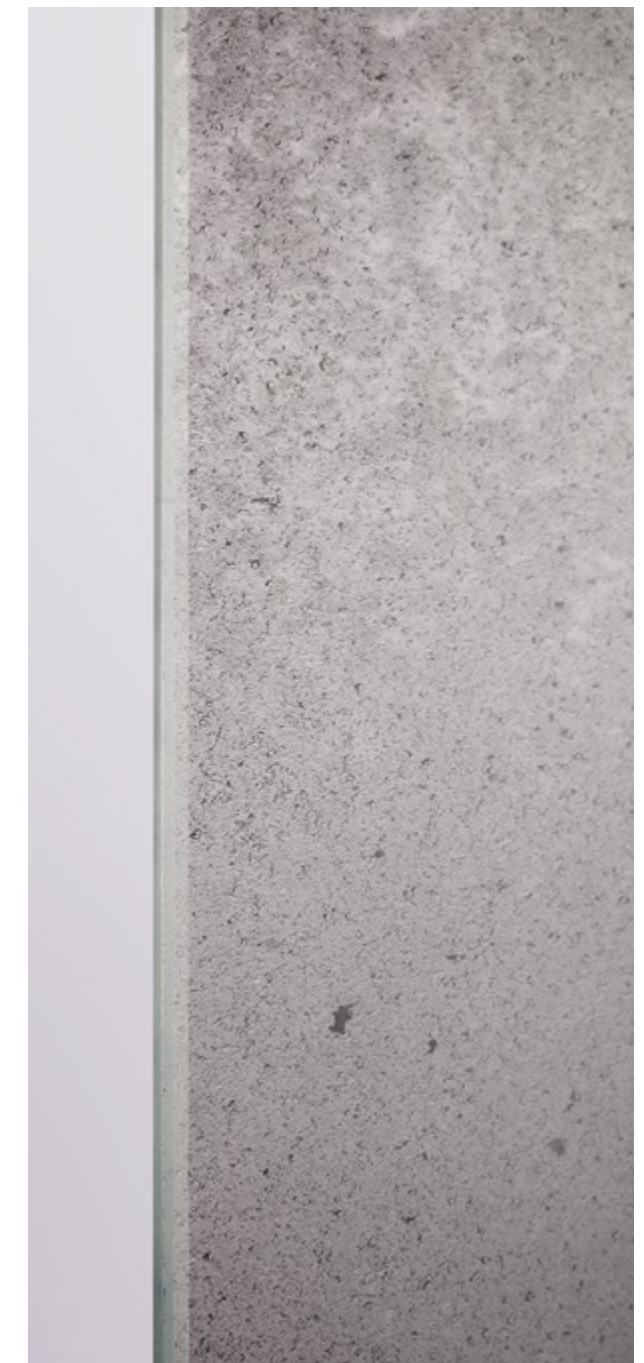

GREY PLASTER
cod. M300-5

FINITURA ALLUMINIO PER PROFILI, STIPITI E ACCESSORI

_ALUMINUM FINISH FOR PROFILES, FRAMES AND ACCESSORIES

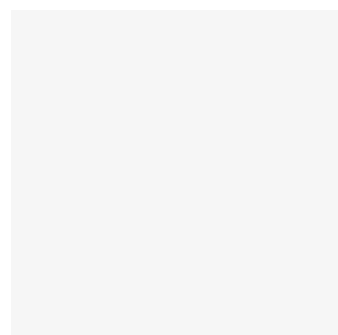

Bianco
_White



Alluminio
_Aluminum



Nero
_Black



Titanio
_Titanium

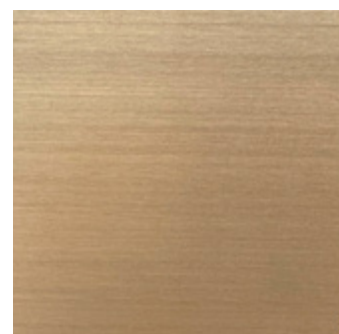

Ottone
_Brass



Moka
_Moka

Non si garantisce l'omogeneità cromatica degli elementi realizzati in alluminio anodizzato che possono presentare delle leggere differenze di colore dovute al lotto di produzione da cui provengono.

The chromatic homogeneity of the elements made of anodized aluminum is not guaranteed, which may have slight color differences due to the production batch from which they come.

SPECIFICHE E NOTE TECNICHE

_SPECIFICATIONS AND TECHNICAL NOTES

Per quanto riguarda la collezione Wallpaper:

- Il decoro non viene riproporzionato al cambiare della misura dell'anta, quindi i tagli del decoro non sempre seguiranno la modularità dello stesso.

- Per una progettazione ottimale, in particolare per il decoro Heritage, la larghezza dell'anta andrebbe calcolata come multiplo del modulo-base del decoro la cui misura può essere richiesta all'azienda.

- Nei progetti che vedono le porte abbinare alle carte da parati, è consigliabile utilizzare porte a tutta altezza per evitare problemi di allineamento del decoro nella parte superiore della parete.

Per i modelli GRID 06 e GRID 07, le porte a battente Manhattan con maniglia Life possono essere realizzate solo se l'anta ha una larghezza superiore a 670 mm.

I materiali utilizzati sono tutti di prima scelta e, per quanto riguarda il collaudo dei prodotti, l'azienda si è avvalsa dei criteri previsti dalle normative in materia.

Per motivi legati alla stampa i colori riprodotti in questo catalogo possono differire dai colori reali dei manufatti; quindi i colori riprodotti nel catalogo sono indicativi.

All'interno del catalogo le misure sono espresse in mm.

Regarding the Wallpaper collection:

- The decoration is not re-proportioned when the door size changes, so the decoration cuts will not always follow the modularity of the same.

- For an optimal design, in particular for the Heritage decoration, the width of the door should be calculated as a multiple of the basic module of the decoration; this size can be requested to the company.

- In projects where the doors match the wallpaper, it is advisable to use full-height doors to avoid problems with alignment of the decoration at the top of the wall.

GRID 06 and GRID 07 models require a minimum door width of 670 mm to be realized. This requirement is applied to the Manhattan swing doors with Life handle.

The materials used are all first choice and, with regard to product testing, the company has used the criteria provided for by the relevant regulations.

For reasons related to printing, the colors reproduced in this catalog may differ from the real colors of the products; therefore the colors reproduced in the catalog are indicative.

Within the catalogue, dimensions are expressed in mm.

HenryGlass®

HenryGlass srl

Via Portobuffolè, 46 A/B

31040 Mansuè (TV) Italy

Tel. +39 0422 209411

Fax +39 0422 209494

www.henryglass.it

info@henryglass.it

HS042.22 rev. 0.0 del 01-02-2022

Concept & Art Direction: Nicola Gallizia Design

Pre-press: Tipografia Asolana srl

Images: Nerokubo - PN

Coordination: Ufficio Marketing Henry glass

Print: Tipografia Asolana srl

Nessuna parte di questo catalogo può essere riprodotta in qualunque forma senza autorizzazione di HenryGlass srl.

_All right reserved. No part of this publication may be reproduced in any form without prior permission from HenryGlass srl.

I prodotti rappresentati in questo catalogo si riferiscono al momento della pubblicazione. HenryGlass srl si riserva il diritto di variare colori, misure, materiali e disegni e di eliminare qualsiasi articolo ogni qualvolta lo ritenga necessario, anche senza preavviso.

_The products depicted in this catalogue are true to specifications at the time of publication. HenryGlass srl reserves the right to any given changes as to materials or finishes without advance notification. The presentation and materials shown provide only a point of reference.